

5+

STANLEY® Jr.

PULL BACK SPORTS CAR KIT

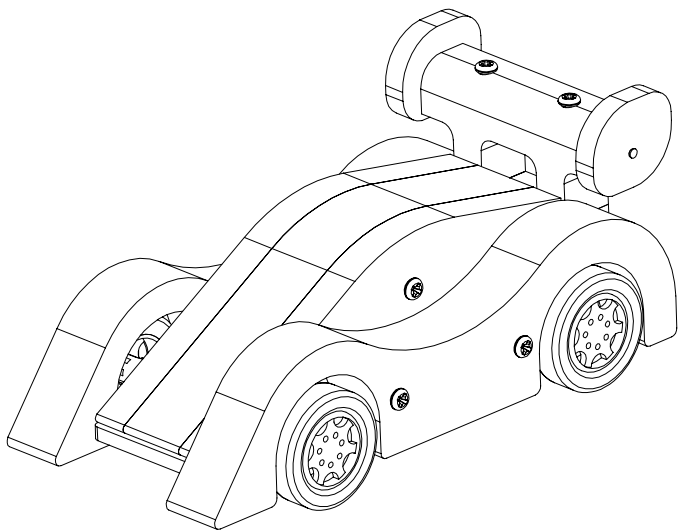

ASSEMBLY INSTRUCTIONS

ATTENTION! Parental guidance and direct supervision required at all times.

STANLEY® Jr.

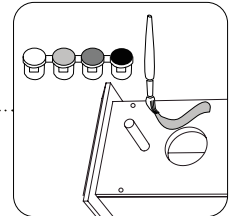
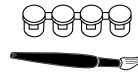
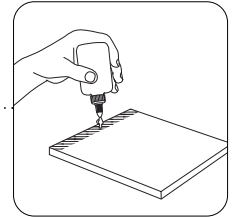
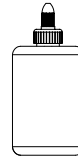
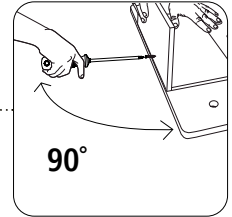
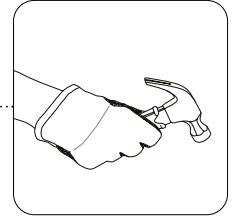
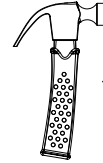
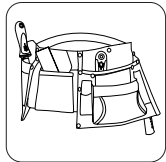
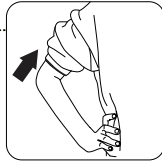
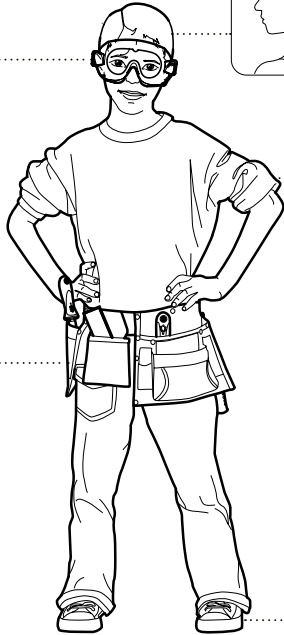
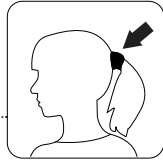

ASSEMBLY INSTRUCTIONS

30min

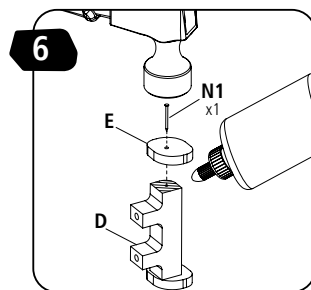
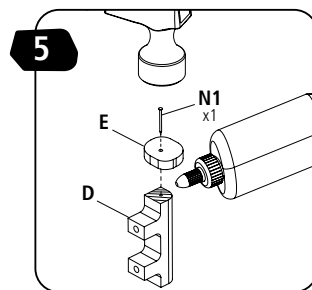
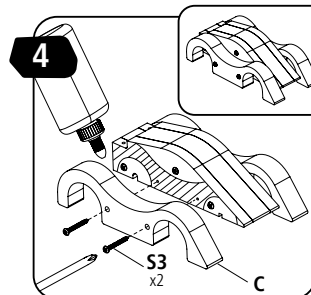
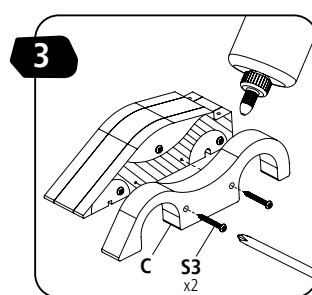
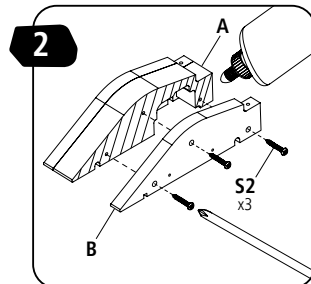
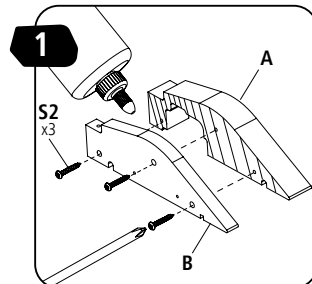
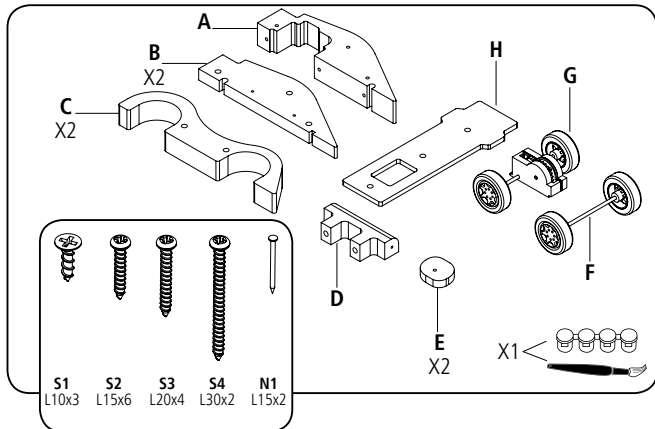
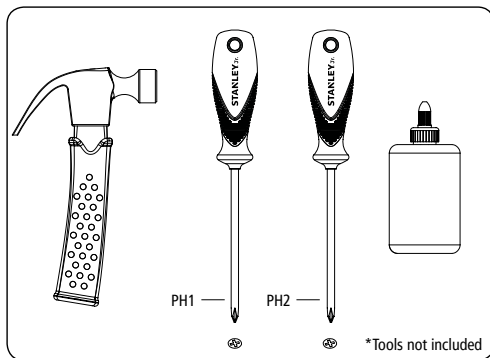

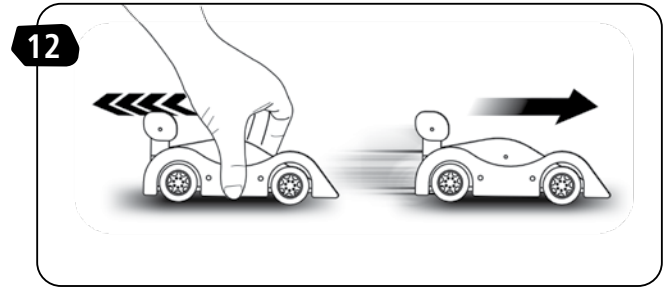
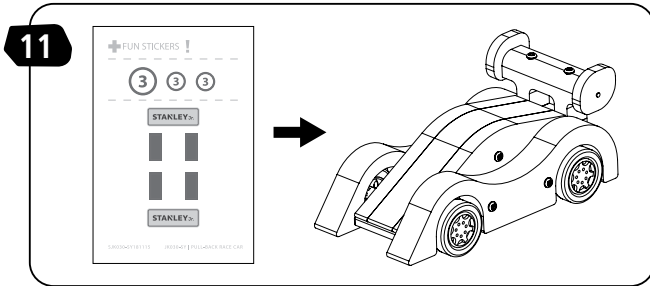
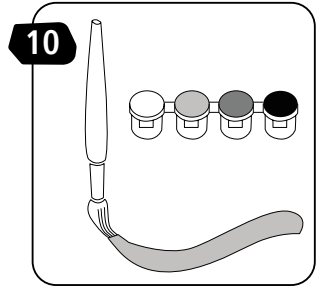
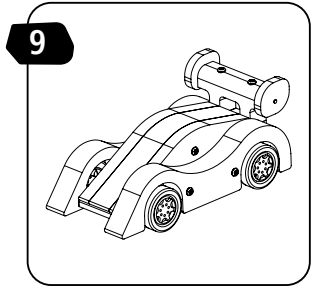
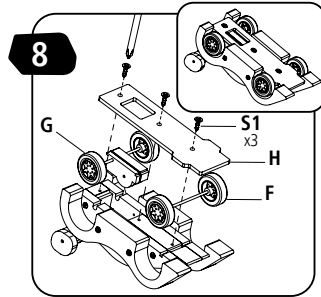
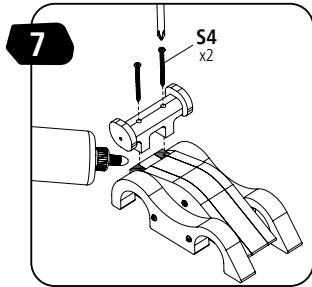

STANLEY® Jr.

©2019 Stanley Black & Decker, Inc.
STANLEY®, STANLEY® Jr. and the STANLEY®
and STANLEY® Jr. logos are trademarks of
Stanley Black & Decker, Inc. or an affiliate thereof
and are used under license. All rights reserved.

Products are manufactured by:

Red Tool Box Ltd.
Yun He, Zhejiang Province, China
Made in China



WARNING:

CHOKING HAZARD-

Small parts.

Not for children under 3 yrs.



CAUTION:

FUNCTIONAL SHARP POINTS

AND EDGES- Use with care.

Adult Supervision Recommended.