

# BIOTIC

ENTERPRISES LLC

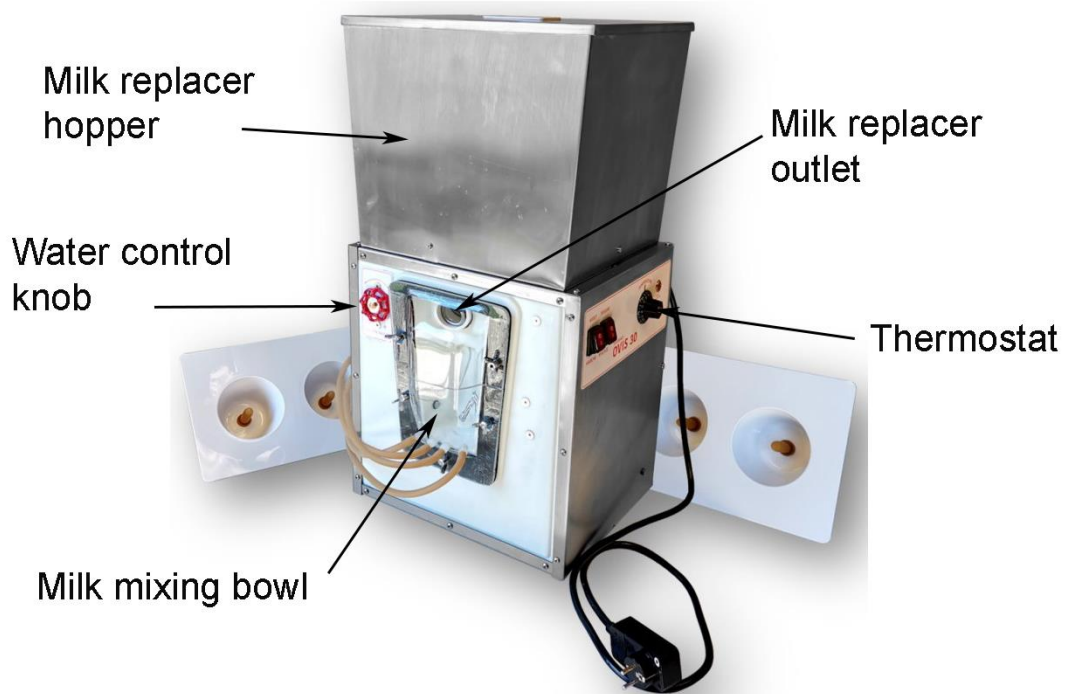

## LAC-TEK Ovis-40

### AUTOMATIC LAMB & KID FEEDER

BIOTIC ENTERPRISES LLC  
45 High Point Ave, Suite 2  
Portsmouth, RI 02871 USA  
1-877-816-0379  
[www.biotic.com](http://www.biotic.com)

The operator's satisfaction with this unit will depend to a great extent on his/her management of other factors involved in the raising of young animals, such as proper housing, good sanitation practices, control of diseases and types of milk replacers/formulas used. All these factors, including the number of lambs on the OVIS-40 LAC-TEK should be considered in selecting the proper location and setting up the machine.

All advice given in this manual is intended to serve as a guideline only.

## SAFETY PRECAUTIONS

### **Read this section carefully before proceeding.**

Before connecting the electricity, make sure that the Main Switch (on/off) is on the off position and **THE THERMOSTAT IS SET AT ZERO.**

Do not open the control panel without removing the electric plug from the socket. Shut off the main power source (breaker) before attempting this.

When filling up the hopper, make sure that there is no foreign matter (measuring cup, string, paper, etc.) in the powder.

Note: All references to measurement are in U.S. followed by the metric equivalent.

## SPECIFICATIONS

The OVIS-40 LAC-TEK is an automatic dispenser designed to provide a constant, uniform and easily accessible supply of milk replacer/formula for various domestic animals such as lambs, and kids.

The machine automatically mixes small quantities of powdered milk replacer/formula with warm water at a desired concentration. The animals take the mixed liquid by means of a rubber nipple.

The machine consists of a hopper, water tank and heater, mixing bowl with outlets for the nipples and an electro-mechanical system which mixes the powdered milk substitute and water in desired proportion and temperature. The mix is made in batches. When the milk level goes below the sensor, the feeder starts a new batch.

The water enters the heating tank via a valve where it is heated by a thermostatically controlled element.

The concentration of the mix is regulated in the following manner:

The milk replacer flow is always constant.

The water flow to the mixing-bowl is adjustable.

Capacity	:	40 lambs or kids
Number of nipples	:	4 for lambs and kids
Capacity of hopper	:	25 lbs. (9 kg)
Capacity of water tank	:	2 gal. (8 l.)
Current rating	:	110 volts, 1500 watts
Power requirement	:	15 amps
Dimension	:	17X19X28" (43X48X70 cm)

## OVIS-40 LAC-TEK CONTROL PANEL

\*\*Always ensure that the temperature is OFF before turning the machine ON.



# SUGGESTED HOUSING LAYOUT

Pen #1  
12' X 20'

Pen #2  
12' X 20'

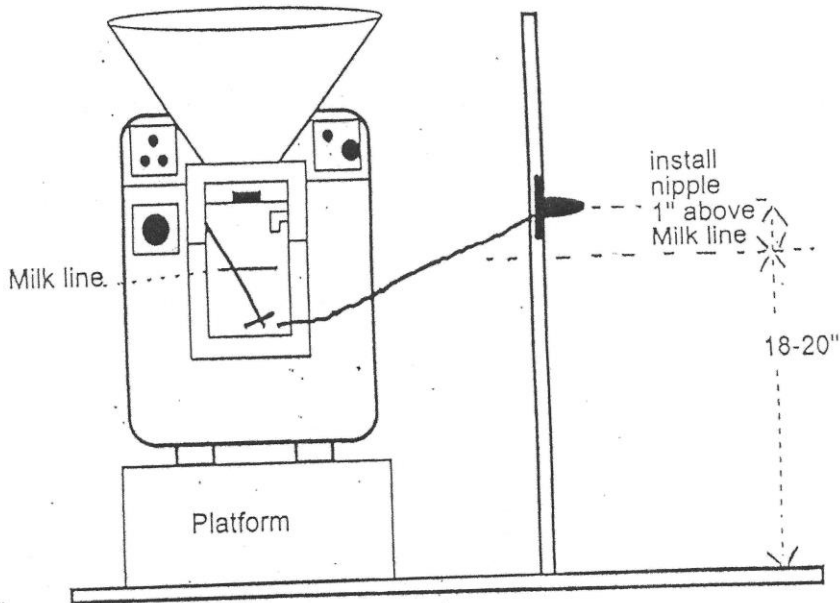
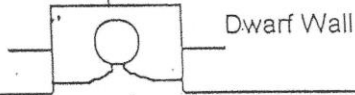

## INSTALLATION OF THE OVIS-40 LAC-TEK

### **Site:**

The maximum number of lambs to a machine is determined more by environmental and husbandry considerations, rather than the capacity of the machine. Our general recommendation per unit is 40 lambs, managed in good housing conditions.

Ideally, the OVIS-40 LAC-TEK should be in a recess to afford easy access for daily cleaning and maintenance (see Suggested Housing Layout diagram).

Install the OVIS-40 LAC-TEK in the access passage adjoining the lamb pens. The distance from the nipple outlets on the OVIS-40 LAC-TEK to the nipples on the wall of the pen should be no greater than 3 feet (1 meter). Locate the nipples about 14 inches (51 cm) up from the floor of the pen.

The OVIS-40 LAC-TEK must be placed so that the nipples are about 1/2 inch (1.2 cm) above the level of the milk in the mixing bowl. In most cases a platform will have to be used for the OVIS-40 LAC-TEK to achieve the proper height.

### **Water:**

The ideal water pressure for the OVIS-40 LAC-TEK lies between 15 p.s.i (0.8 kPa) to 80 p.s.i. (5.50 kPa). A garden hose connection is ideal as it supplies an adequate water flow to the OVIS-40 LAC-TEK. You should have a back flow protection valve before it connects to the water source.

### **Electrical:**

Electricity connection must be via a 15 amp plug and socket with a 15-amp breaker. The OVIS-40 LAC-TEK will have to be plugged into a 110 outlet. Please plug machine into a GFCI outlet (ground fault circuit interrupter).

## OPERATION

After installation has been completed, operate the OVIS-40 LAC-TEK without milk replacer/formula powder in the hopper until you are thoroughly familiar with the function of each part of the machine.

**Do not plug the machine to electricity yet.**

1. Connect water hose to feeder. Open main water faucet all the way. Check lines and fittings for water leaks.

**2. MAKE SURE THE THERMOSTAT IS IN THE OFF POSITION.**

Now plug the machine in.

Turn The ON/OFF switch on

Water should start filling up water tank. Wait until the water fills up the mixing bowl. (About 5 minutes). When the water reaches a certain level, everything stops

**IF THE FEEDER STOPS, TURN ON-OFF SWITCH ON AND OFF TO START THE FEEDER**

**AGAIN.** (This a security design that if there is no water coming to the mixing bowl for 10 cycles the feeder will stop.)

4. Turn the thermostat to the 30-40 degrees Centigrade position. ( $37^{\circ}\text{C} = 98.6^{\circ}\text{F}$ ). The red light is on and will go off when the water reaches the desired temperature.

5. Turn POWDER/RINSE SWITCH to powder position.

6. Drain the mixing bowl by removing one hose from the nipple. When the water level goes below the sensor level the machine will start again. The powder and mixing motor are running, and water fills the bowl. Reconnect hose. (If machine does not start or overflows see Trouble Shooting).

Repeat this procedure until you are familiar with the operation of the OVIS-40 LAC-TEK.

7. You are now ready to calibrate your OVIS-40 LAC-TEK.

## CALIBRATION OF THE OVIS-40 LAC-TEK

1. Fill the hopper with milk replacer.

MAKE SURE THERE ARE NO CUPS OR  
OTHER FOREIGN MATERIAL IN THE MILK REPLACER.

2. Turn POWDER/RINSE switch to powder position

3. Hold a small container under milk outlet.

4. Drain the mixing bowl by removing the nipple hose from the nipple. When milk does not touch sensor probe the feeder will run for 5 seconds.

5. Weigh the amount of milk powder. Write down amount. It gives you quantity of milk replacer in 5 seconds. This quantity does not change. (Only if you change the brand of powder)

5. Turn POWDER/RINSE switch to rinse position

Drain the mixing bowl by removing the nipple hose from the nipple. When milk does not touch sensor probe the feeder will run for 5 second.

Weigh the amount of water. Write down amount. It will give you quantity of water in 5 second

To make the concentration you will have to adjust **only the water**

For Example

We want a concentration of 8 oz. /quart. (1 quart = 32 oz.). So, we are looking for a ratio of 1 part powder to 4 parts water.

After weighting the powder, we have 2 oz. of milk replacer in 5 second. So, for 2 oz powder we need 8 oz. of water

In 5 second we need to find 8 oz. to have a concentration of 8 oz. per quart.

By turning clockwise or counterclockwise the concentration knob we can adjust the quantity of water to 8 oz.

Another way to do the concentration (but not as precise) is to

---Drain the mixing bowl by removing the nipple hose from the nipple

-----pour 1 pint in the mixing bowl scratch on the bowl where the pint stops.

1. To do the concentration:

2. Turn on/off switch off

3. Turn powder switch on rinse.

4. Drain the mixing bowl by removing the nipple hose from the nipple

5. Hold a container under powder outlet

6. Turn on/off switch on.

When water reach the pint mark turn on/off switch off

Weight powder, you will have the quantity of powder to mix one pint.

Turn concentration knob clockwise or counterclockwise to have the desire concentration.

Note: Don't forget to weigh the measuring cup first and subtract that from the weight of the cup and the powder.

WHEN DESIRED CONCENTRATION IS ATTAINED, TURN ALL SWITCHES ON

It is important that your milk replacer/formulas are weighed in calculating the desired concentrations. Not all milk replacer/formulas have the same bulk densities. Weights can also vary due to compaction of the milk substitutes.

## MAINTENANCE

The importance of thorough daily cleaning and regular maintenance cannot be over-emphasized. Clean bowl, nipple hoses, nipples, and nipple-plates daily.

For the daily cleaning operation, shut the machine off. See that a lamb drains the bowl to reduce waste.

Disconnect the nipple tubing from the nipple connectors. Turn the POWDER SWITCH to the rinse position and allow warm water to circulate in the mixing bowl. Drain wastewater into a suitable container. (A safe dairy cleaner-sanitizer solution can be used). All parts exposed to the liquid milk substitute should be thoroughly cleaned and rinsed.

### CAUTION:

Turn off the main switch before removing the bottom part of the mixing bowl cover, then clean the bowl and bowl covers with a soft sponge or soft bristle brush.

Inspect agitator blade to be sure no foreign material has collected around the blade or shaft.

Make sure that the opening in the bowl for the milk powder is clean and free of any foreign objects.

**DO NOT WASH THE PANEL BOARD WITH WATER: YOU COULD RUN THE RISK OF SHORT-CIRCUITS.**

Do not let the OVIS-40 LAC-TEK run out of milk replacer/formula.

## STORAGE

When the OVIS-40 LAC-TEK is to be inactive or stored, for even a day, it is important that all the above cleaning and maintenance steps be performed, and all feed should be removed from the hopper.

The water tank in the OVIS-40 LAC-TEK should be drained, particularly if the OVIS-40 LAC-TEK is shut-off, stored, or in the event of a power-failure during freezing weather. Doing this is very easy on the OVIS-40 feeders by using the draining hose attached to the water tank. The heating element does not need to be removed for this purpose. For draining the tank, please follow these steps (use picture for reference):



1. Unplug the feeder.
2. Remove the right-side panel.
3. Remove the end of the draining hose from the holder.
4. Close valve A.
5. Open valve B.
6. Drain tank by using spout C.

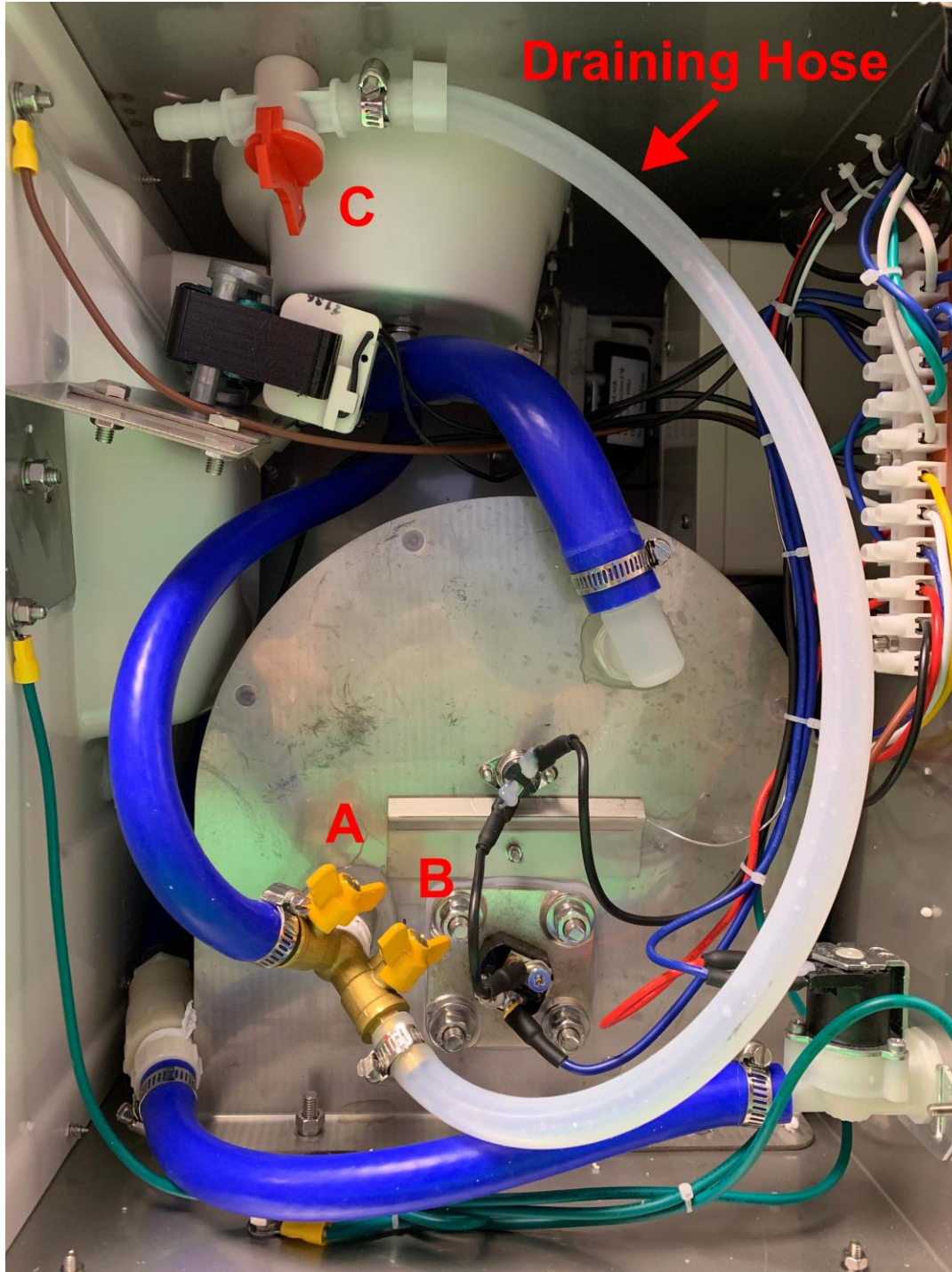

## **HOUSING**

The OVIS-40 LAC-TEK is versatile and adaptable. It can be used in many existing farm buildings with a minimum of conversion costs.

A good building should be peaceful and comfortable, i.e. stress free.

Exposure to drafts, wet and humid conditions, as well as sudden changes in temperature should be avoided as they can be a major contributor to mortality.

Provide for your lambs dry, clean, and sanitary group pens of sufficient size. A minimum of 5 square feet (0.45 square meter) per lamb should be provided.

This machine is not designed to be used in locations where it may be exposed to the weather.

## **TRAINING THE ANIMALS**

Animals can be trained on the machine after three days of colostrum.

Teach the animals to drink from the OVIS-40 LAC-TEK by showing it the nipple and that it can get milk. Watch animals the first few days to assure that they are nursing.

In the following days, it is not necessary to force the animals to feed; unless a lamb has never fed from the OVIS-40 LAC-TEK, it will come back to feed again when it is hungry, and it will not be necessary for you to intervene. All you have to do is check and be sure that all the animals have fed from the machine at least once.

## **LAMBS / KIDS**

Instructions for lambs apply also for kids

**CAPACITY:** 40 lambs or kids

**EQUIPMENT:**

OVIS-40 LAC-TEK for lambs comes supplied with 2 kid/lamb panel. Each kids/lambs panel consist of 2 recessed nipples with appropriate accessories for their hook-up to the OVIS-40 LAC-TEK. Lambs panels can be separated for individual requirements.

**NIPPLE HEIGHT:** 13 to 17 inches from floor (33 to 43 cm)

**MILK REPLACER:**

Use milk replacer designed for lambs. Calf milk replacers are not recommended because they do not meet the nutrient specifications for lambs.

## MILK CONCENTRATION SETTING:

Milk concentration setting remains the same from the first day to weaning. Set between 6 to 7 ounces per quarts of water (180 to 200gm/liter), depending on the nutritive value of your milk replacer.

MILK TEMPERATURE: 40°C (100°F)

## SITE:

Allocate a minimum of 5 square feet per lambs (0.45 square meter). It is best to have no more than 10 to 12 lambs in a group.

## MANAGEMENT TIPS FOR LAMBS OR KIDS

- Provide a warm, dry, draft-free area to start lambs.
- Make sure lambs received colostrum.
- Lambs should be removed as young as possible from sight of the ewe.
- Lambs then should be left several hours without feed before being introduced to feeder.

Teach lambs to nurse. This may take 4 or 5 tries. Check lambs during the next two days to ensure that all are drinking successfully.

Lambs should be grouped according to sizes to avoid unnecessary competition with older and larger lambs. Days old lambs should not be penned with lambs over a week old.

During the period when newborn lambs are being trained to nurse, it is desirable that they maintained close to feeding station. Provide about 2 square feet per lamb (.2 square meters)

Hang light over the feeding station. Lambs will be attracted by the light and will adapt more quickly to the feeding system.

Provide ample fresh water at all times.

Start lambs on high-quality starter at two weeks of age.

Wean at 30 to 35 days of age or about 25 lbs. of weight (11 to 12 kg.) when lambs are eating starter well.

Clean the milk replacer feeding system and utensils regularly and always use sanitary methods.

## LIABILITY DISCLAIMER

Individual results from the use of this machine may vary due to management, environment, genetics, type of milk replacer/formula used, health and sanitation. Therefore, BIOTIC ENTERPRISES LLC does not warrant or guarantee individual results.

Inside Lactek ( right panel remove)

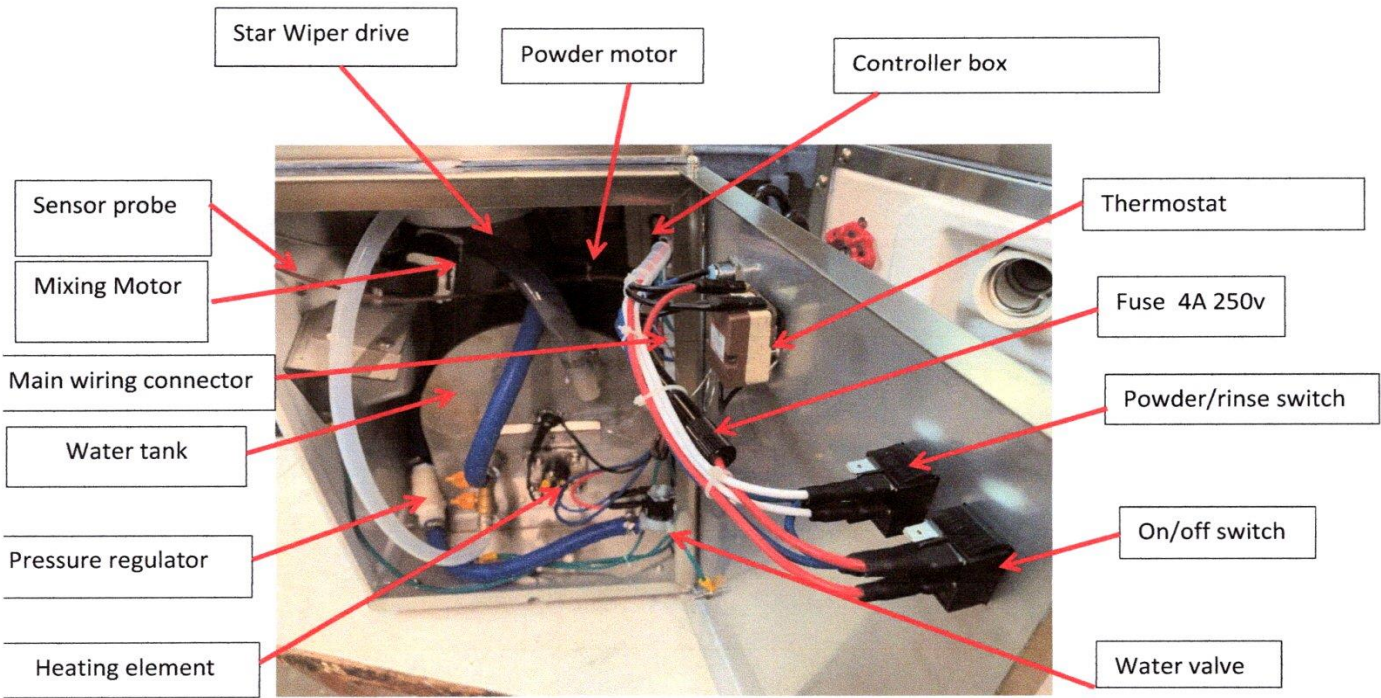

# WIRING

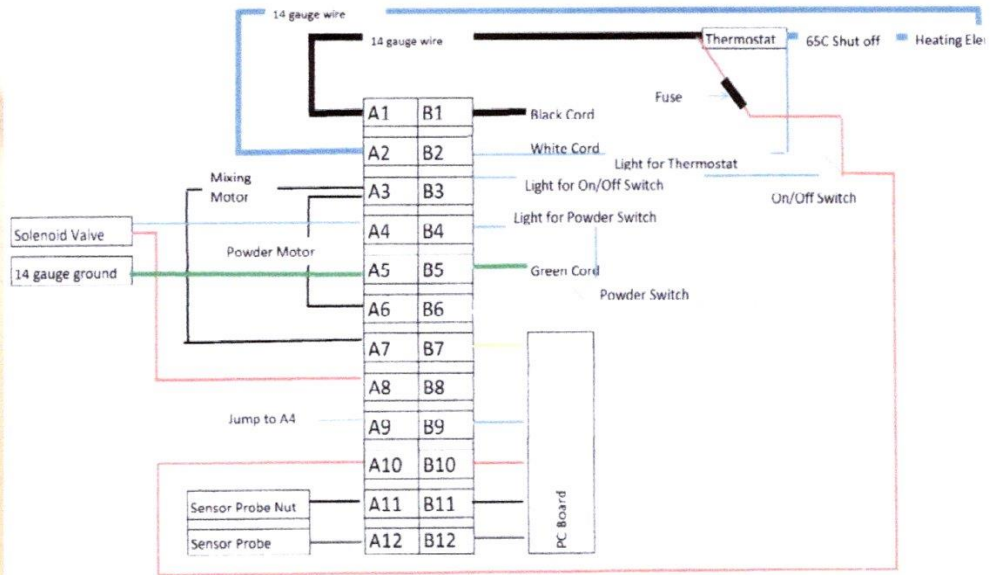
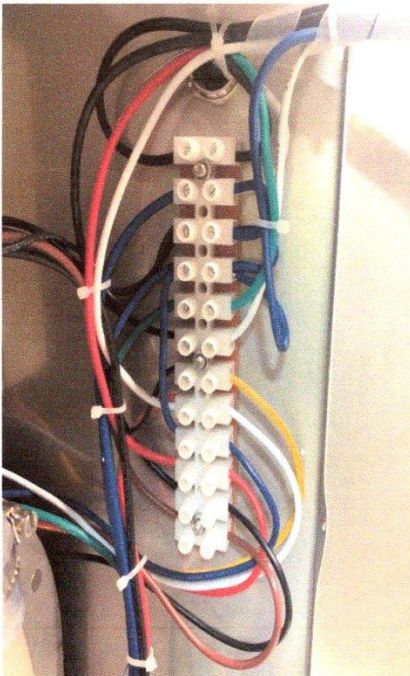

## TROUBLE SHOOTING

CAUTION: DO NOT OPEN THE SIDE PANEL WITHOUT FIRST TURNING OFF POWER TO THE MACHINE.

- |  |  |
|--|--|
| *. Feeder do not start                                   | - Breaker off<br>- Machine unplugged<br>- Switch is off<br>- Bowl full<br>- Fuse Blown   |
| *. No water but powder and Agitator motor working        | - No water going to feeder (faucet shut, etc.)<br>- Concentration knob turned clockwise all the way<br>- Valve filter dirty<br>- Inlet valve defective (replace) |
| *. Mixing bowl filled with powder                        | - Same as above  |
| *. A small amount of water Flowing into bowl             | - Concentration knob turned clockwise all the way<br>- Check water supply  |
| *. <b>No powder but water and Agitator motor working</b> | - Powder switch on rinse<br>- Powder motor stuck<br><b>-Auger unhooked</b><br>- Powder motor defective (replace)   |
| *. Mixing motor not working                              | - Mixing motor dirty<br>- Computer Controller (replace)<br>- Mixing motor defective (replace)  |
| *. Mixing motor does not stop                            | - Computer Controller (replace)  |
| *. Milk overflows, feeder does not Stop                  | -Too much water turn concentration knob down<br>- Computer Controller (replace)  |
| *. Water too warm  | - set thermostat to 40øC<br>- Thermostat out of order (replace)  |
| *. Water does not heat up                                | - set thermostat to 40øC<br>- heating element burned up (replace)  |

## WARRANTY

BIOTIC ENTERPRISES LLC warrants that automatic feeding system number \_\_\_\_\_ has been factory calibrated and tested and is free of defects. Biotic Industries, Inc. will replace any part or parts that fail due to defective material or workmanship within six months from date of delivery provided the warranty card is duly filed within ten (10) days of purchase.

We reserve the right to change specifications or design without notice. Any parts contained in your unit that are different than those listed in this book were changed either to improve your unit or were necessary due to material substitutions.

BIOTIC ENTERPRISES LLC reserves the right to determine cause of failure and the owner agrees to return defective parts to the factory upon request, shipping charges prepaid.

This warranty is not transferable.

## WARRANTY REGISTRATION CARD

**NOTICE:**

**This form must be completed and returned within ten (10) days of delivery to validate the warranty.**

Name of Owner: \_\_\_\_\_  
Phone number: \_\_\_\_\_  
Address of Owner: \_\_\_\_\_ City \_\_\_\_\_  
State: \_\_\_\_\_ Zip \_\_\_\_\_  
Email address: \_\_\_\_\_

BIOTIC ENTERPRISES LLC automatic animal feeding system

Serial No: \_\_\_\_\_  
Machine Model: OVIS-40 LAC-TEK

The primary application of this machine will be:  
Replacement heifers \_\_\_ Veal \_\_\_ Lambs \_\_\_ Kids \_\_\_ Other \_\_\_\_\_

Dealer: \_\_\_\_\_ Date: \_\_\_\_\_

Signature of Owner: \_\_\_\_\_

Mail to:       BIOTIC ENTERPRISES LLC  
                  45 High Point Ave, Suite 2  
                  Portsmouth, RI 02871   USA